

# Sliding door

Installation Manual

## ANIMA RH2

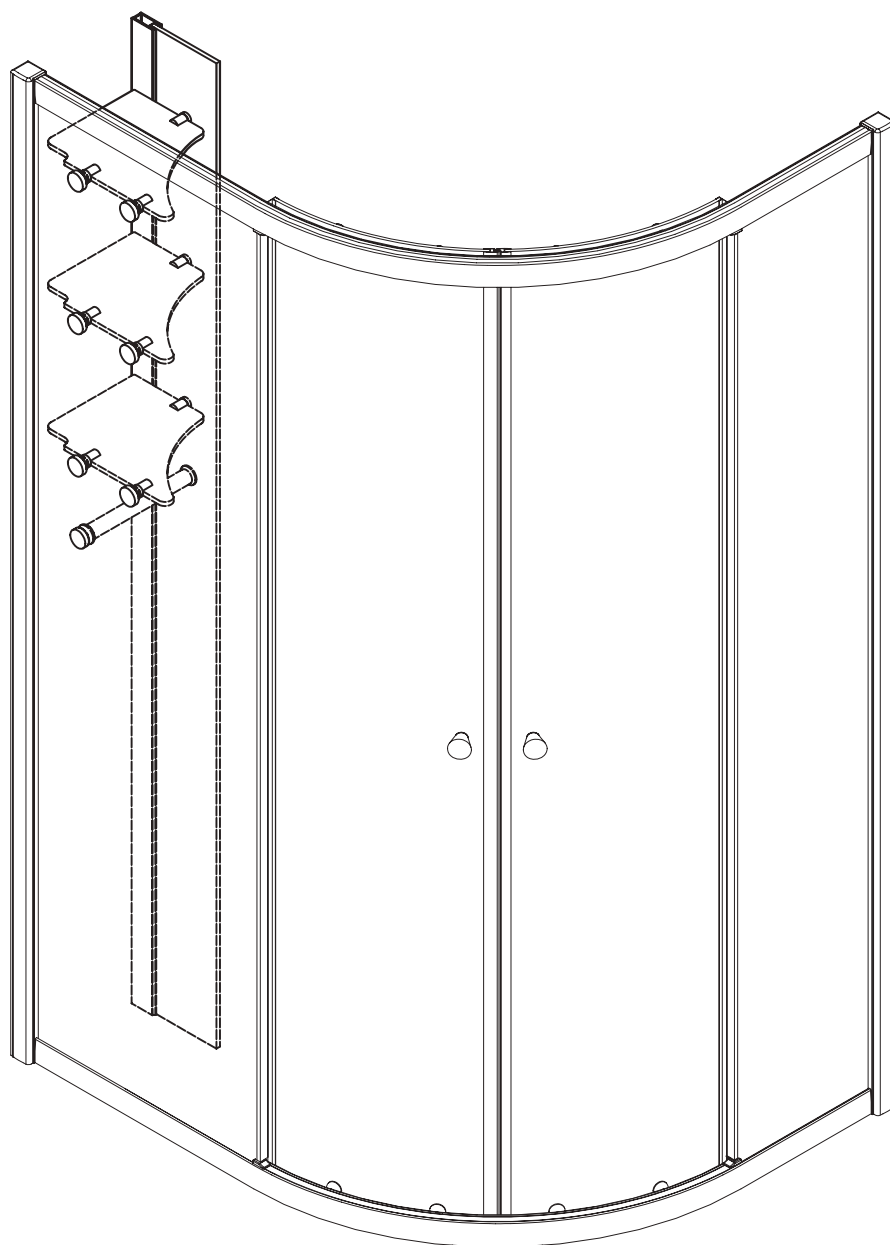

## ■ General Information

Please inspect the product immediately upon receipt for transit damage, missing packs/parts or manufacturing fault. Damage reported later cannot be accepted. Please handle the product with care avoiding knocks and shock loading to all sides and edges of the glass.

**Note: Safety glass can not be re-worked.**

## ■ Installation

Please read these instructions carefully before start of installation.

The wall post has up to 20mm of adjustment for out of true wall situations.

**Ensure that the shower tray is fitted level and that after assembly of enclosure there is a full and continuous bead of sealant between the top of the shower tray and the title joint.**

Special care should be taken when drilling walls to avoid hidden pipes or electrical cables.

Note: This product is heavy and will require two people to install.

Please remove protective film from aluminium profiles before installation.

## ■ Shower Tray Installation

The shower tray must be sited against a structural wall.

Water proof walling or tiling should be fitted so that it sits on the top of the tray rim.

## ■ Aftercare Instructions

After use, your shower should be cleaned with soap and water. This is particularly important in hard water districts where insoluble lime salts may be deposited and allowed to build up. Cleaners of a gritty or abrasive nature should not be used. Care should be taken to avoid contact with strong chemicals such as organic solvents and strippers.

Glass cleaners can be used but with caution, if in doubt contact the supplier of the cleaner in question.

Please keep these instructions for aftercare and customer service details.

## Tools required

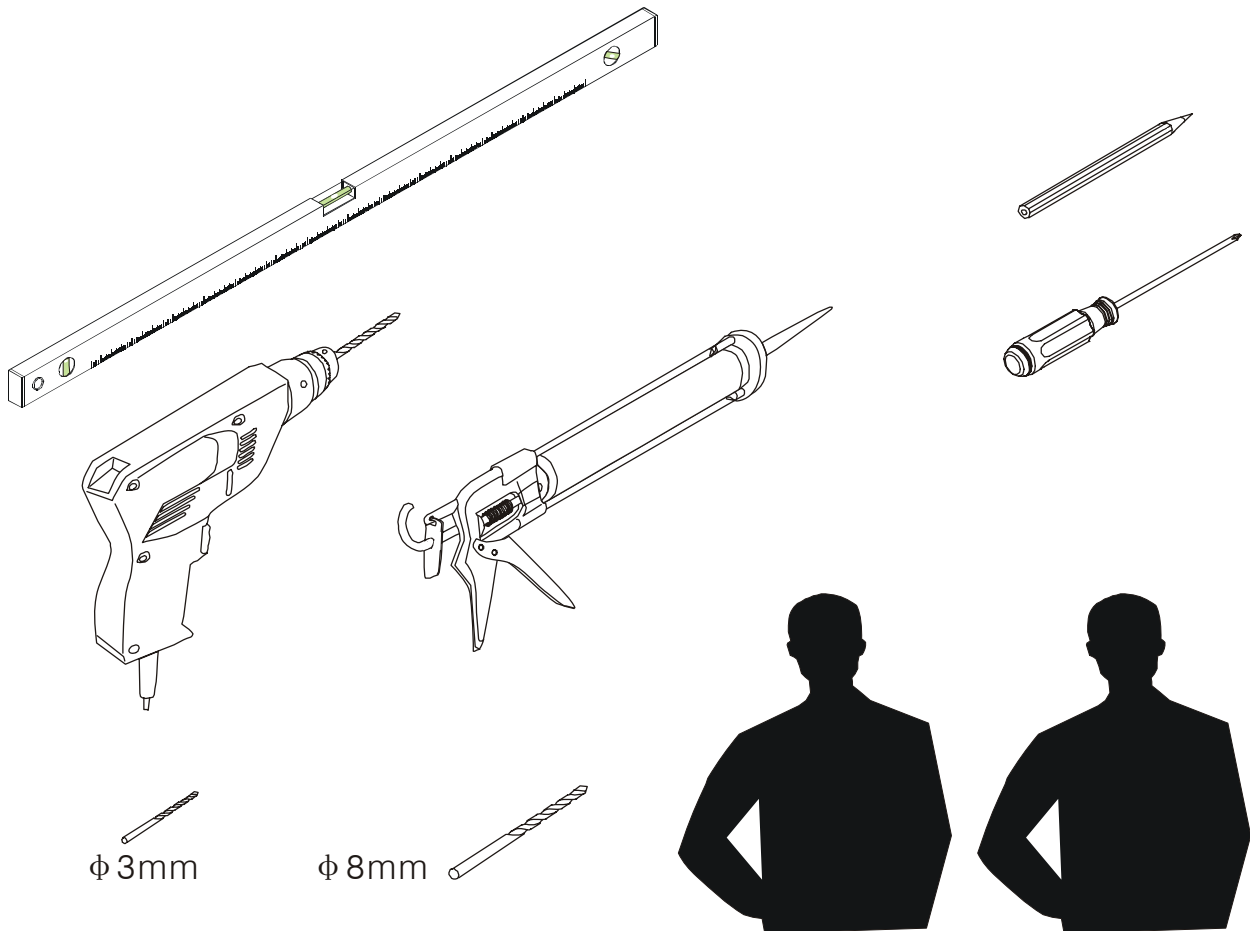

This product is heavy and will require two people to install.



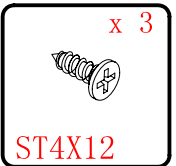
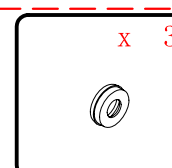
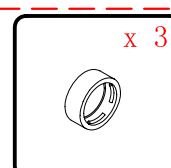
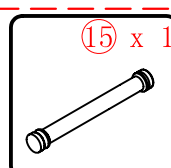
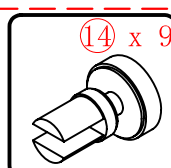
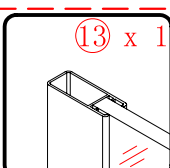
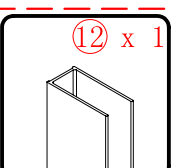
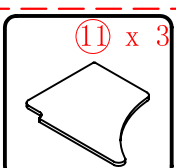
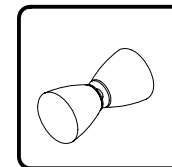
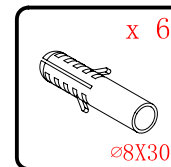
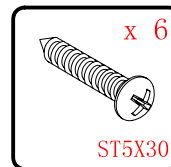
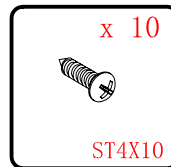
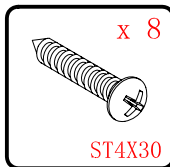
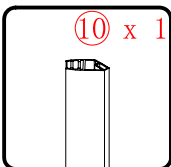
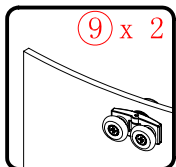
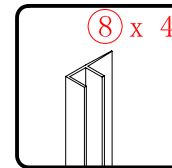
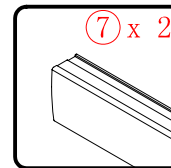
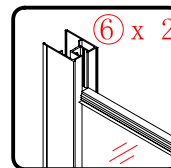
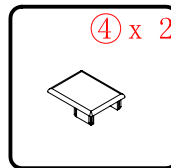
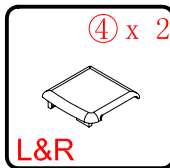
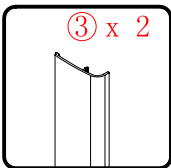
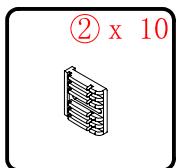
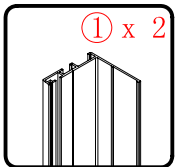
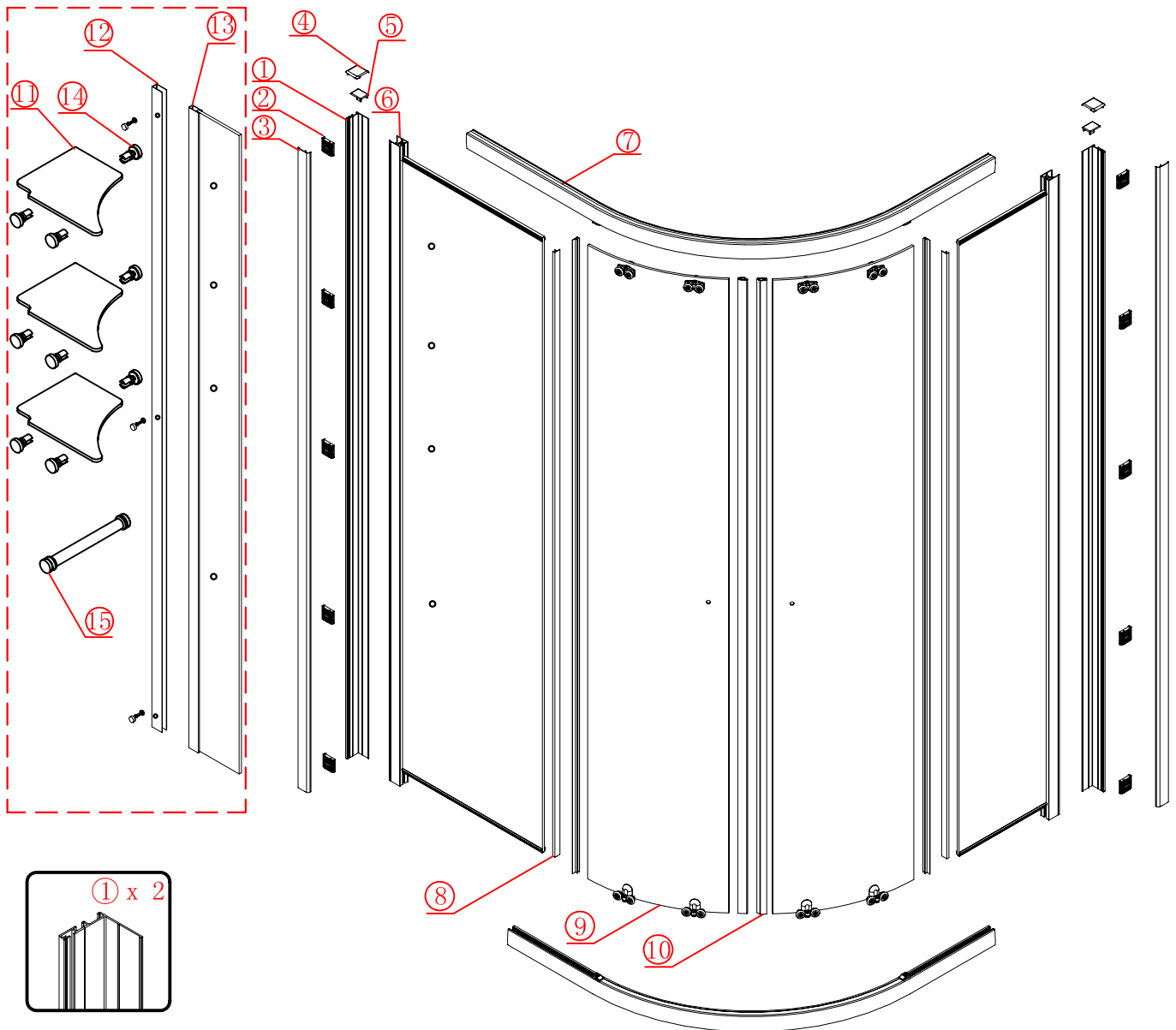

This product is heavy and will require two people to install.



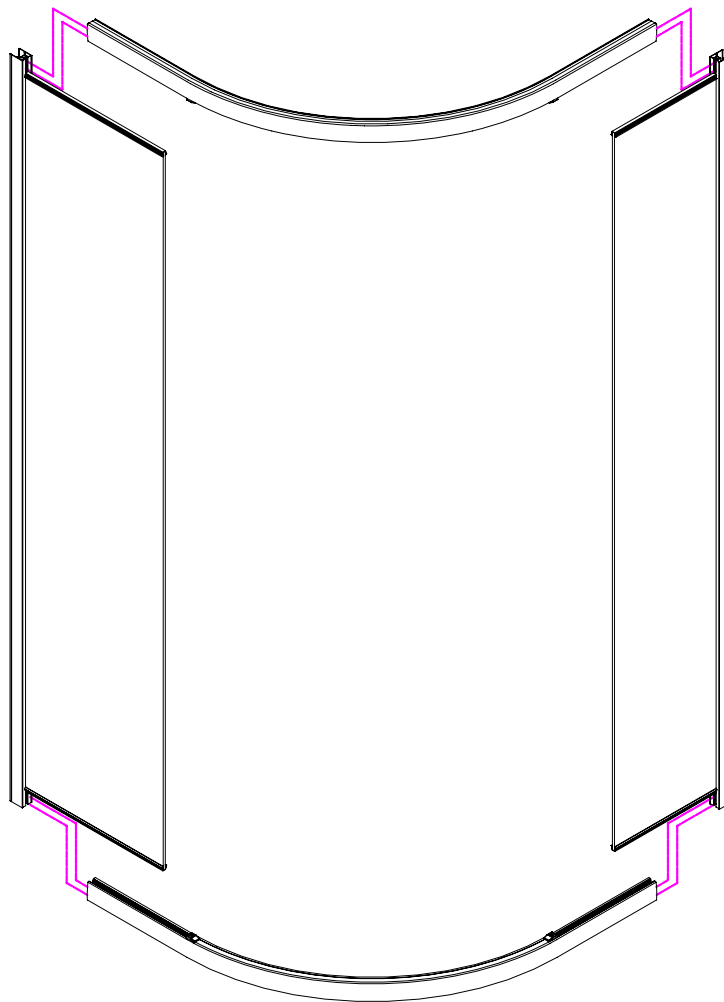
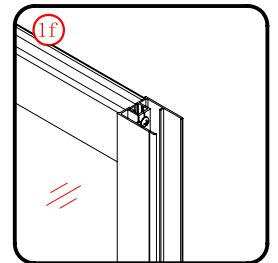
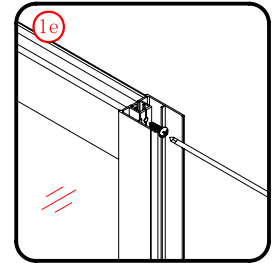
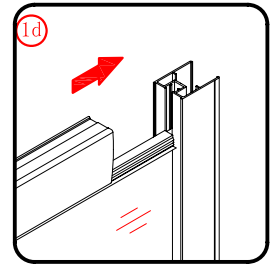
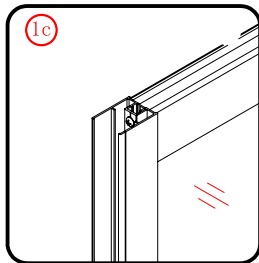
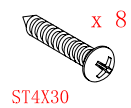
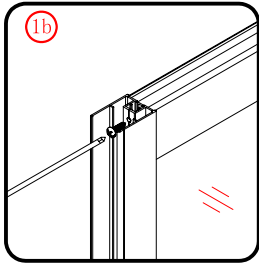
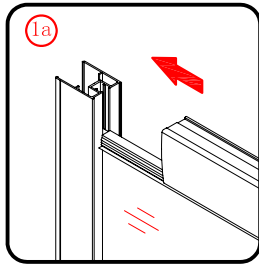

3

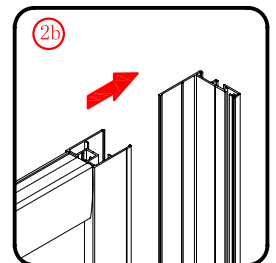
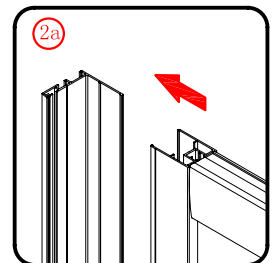
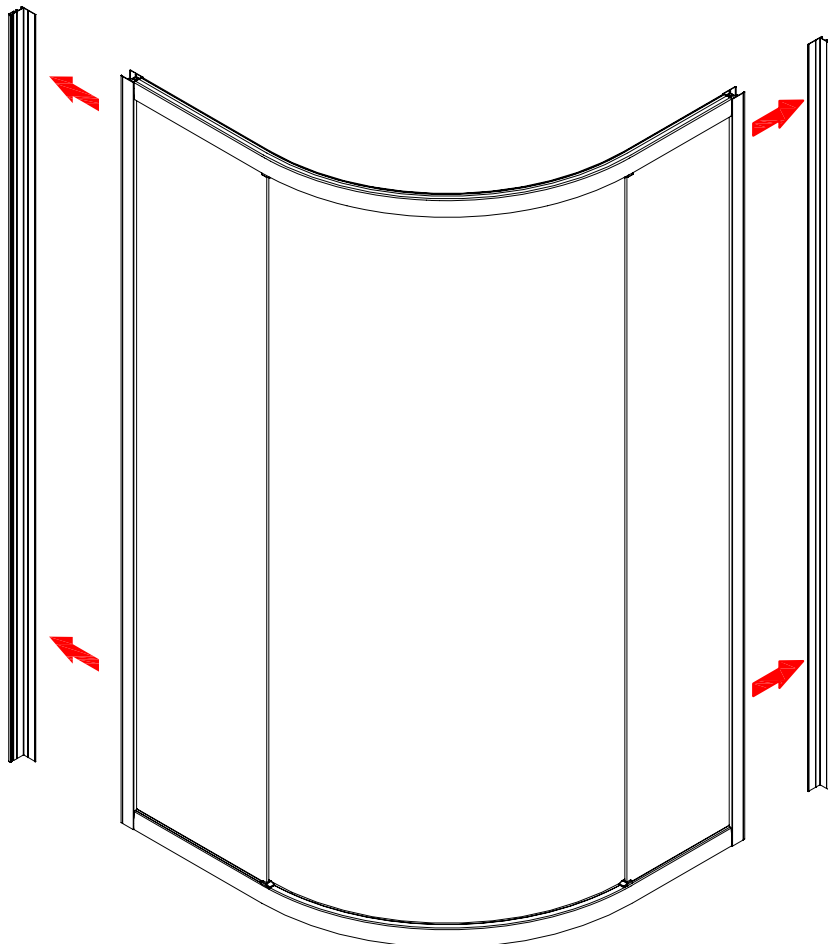

This product is heavy and will require two people to install.



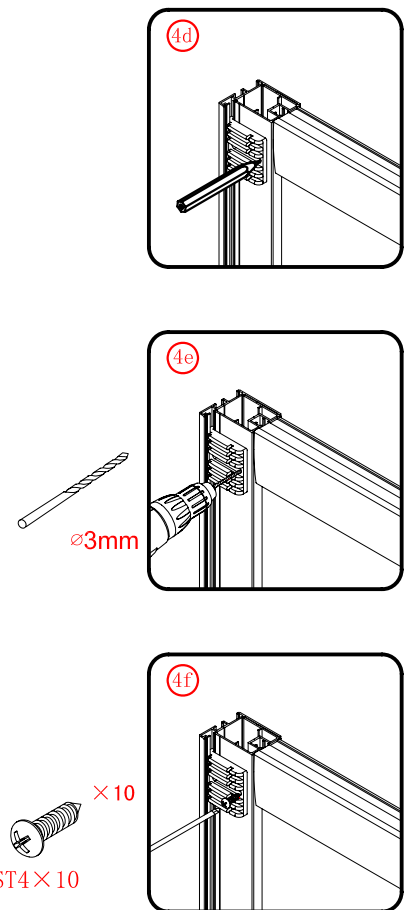
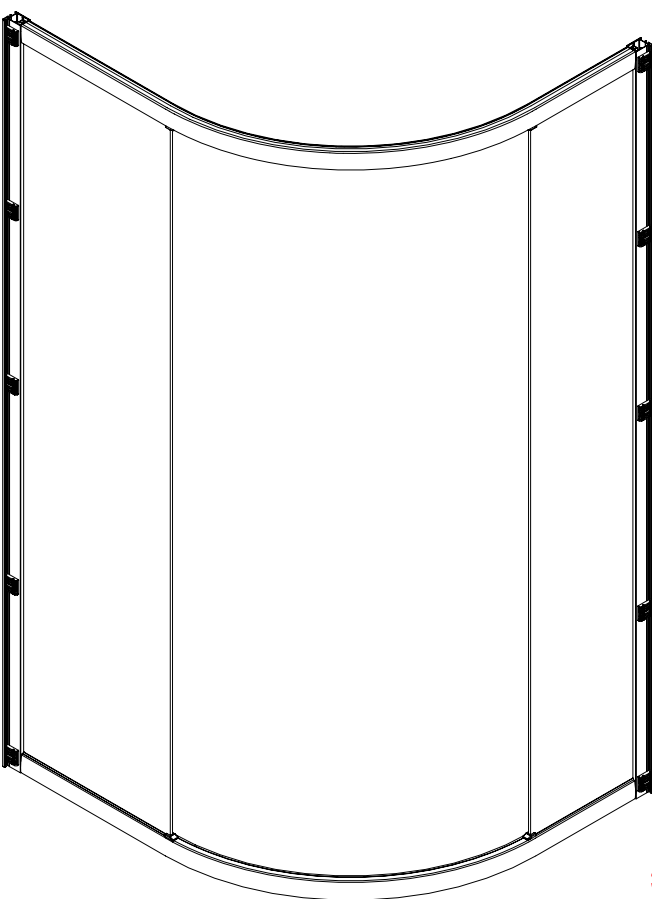
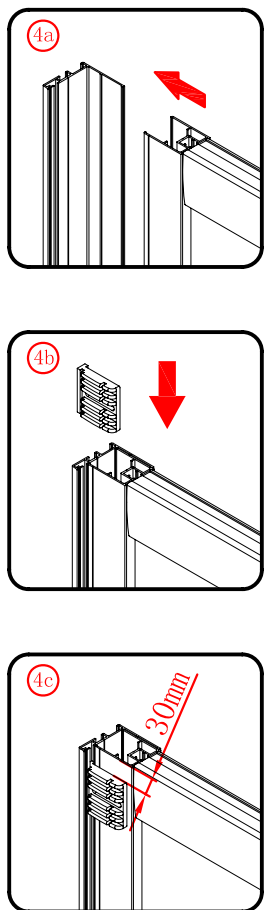
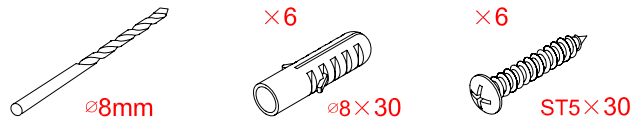
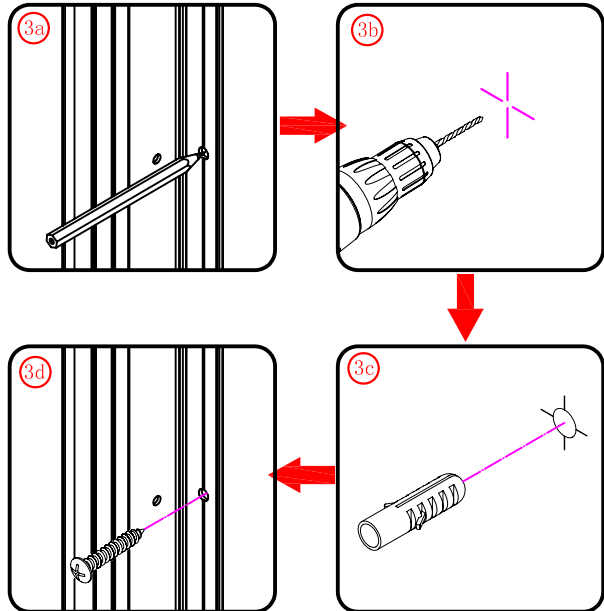
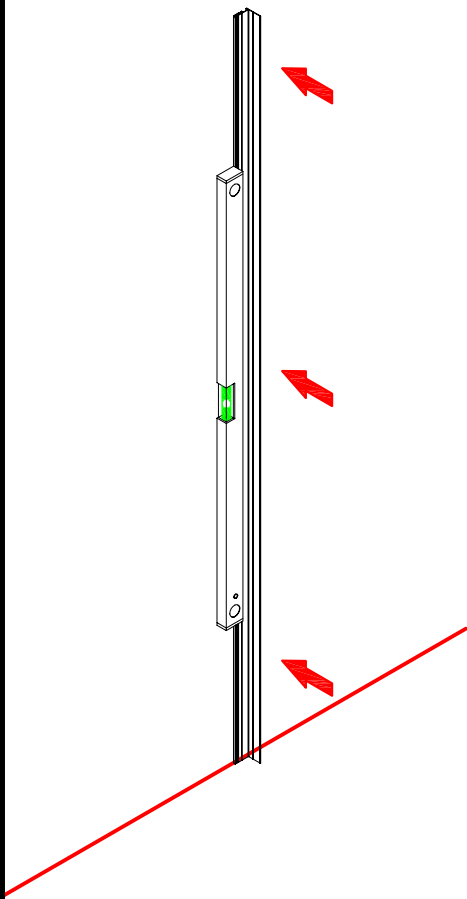

This product is heavy and will require two people to install.



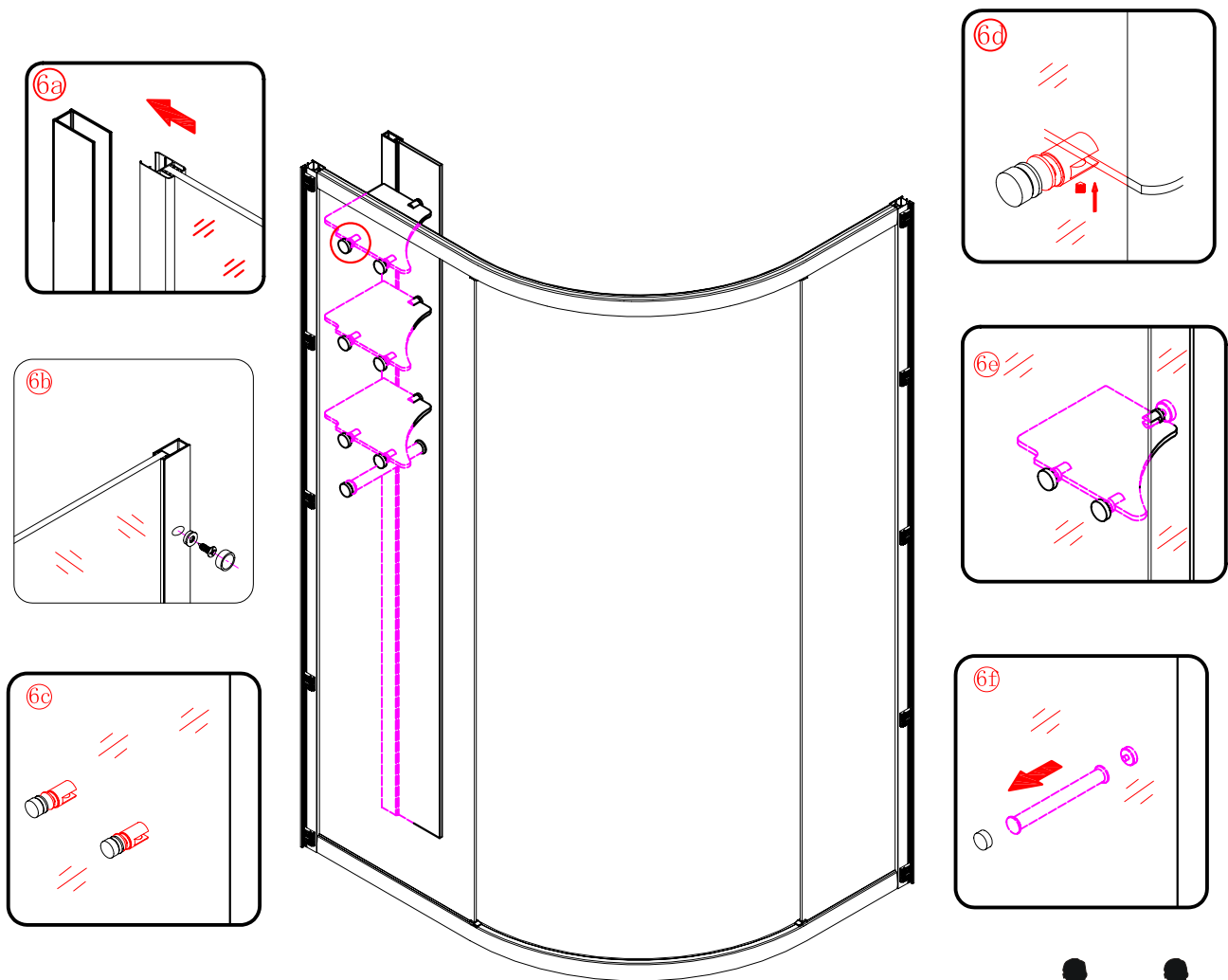
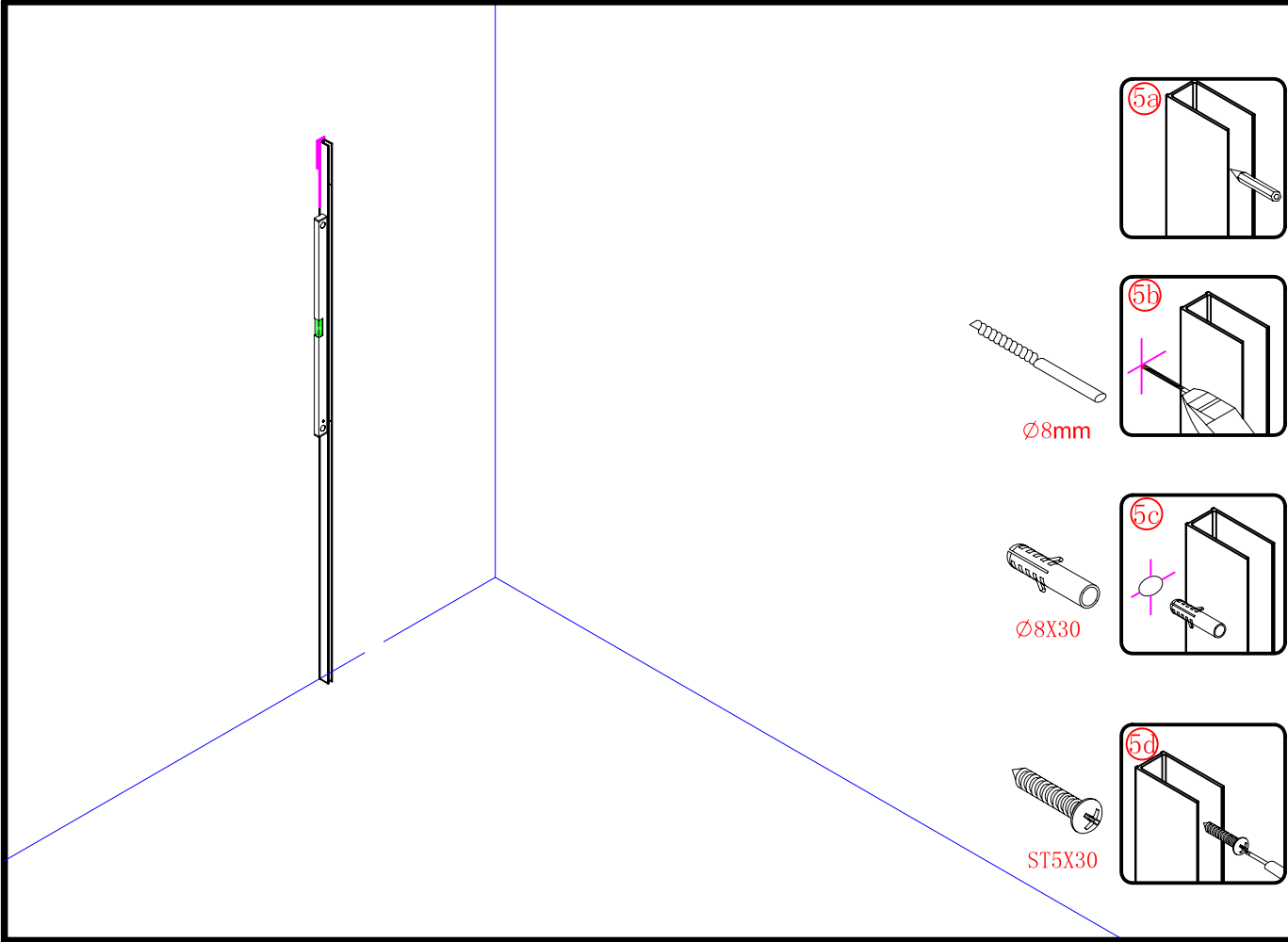

This product is heavy and will require two people to install.



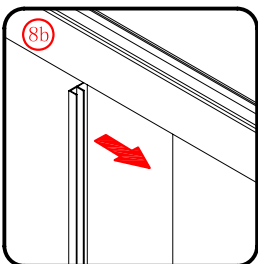
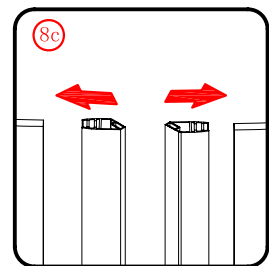
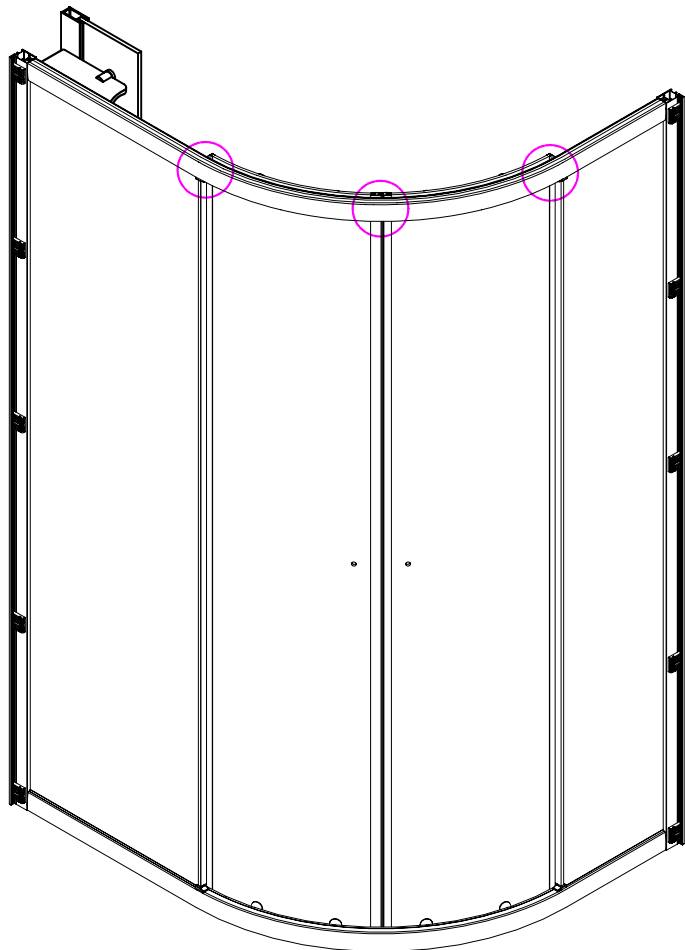
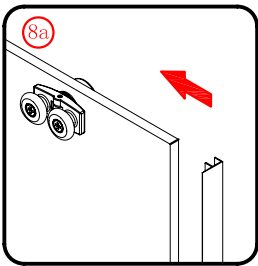
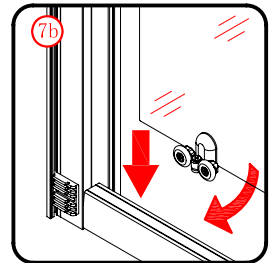
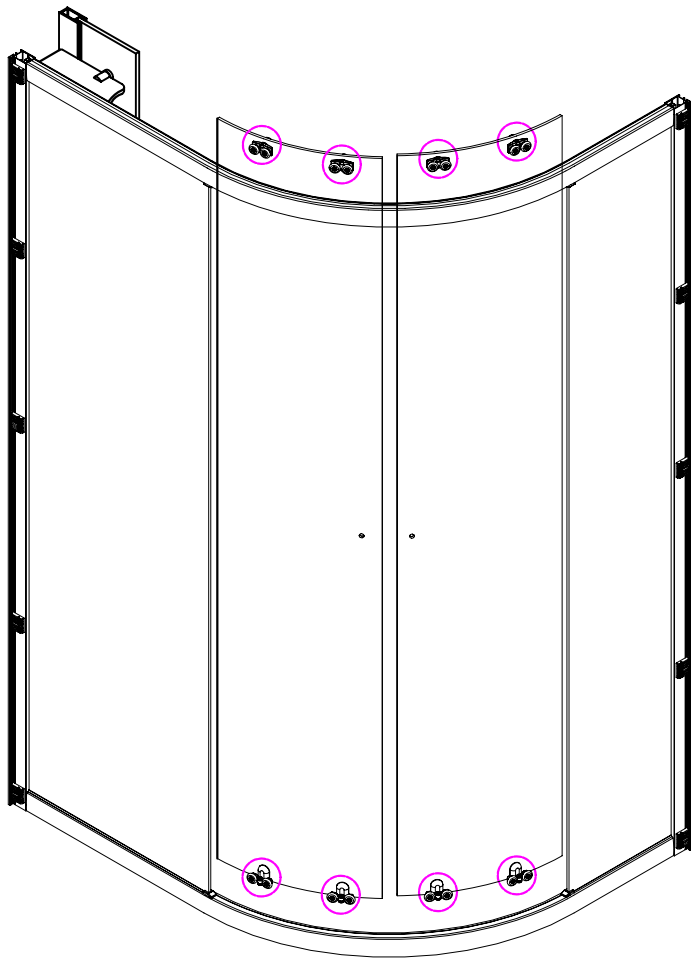
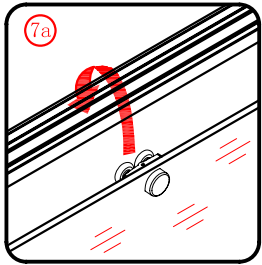

This product is heavy and will require two people to install.



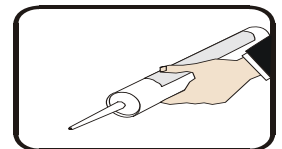
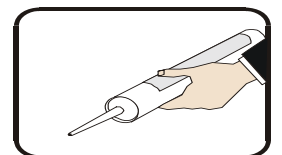
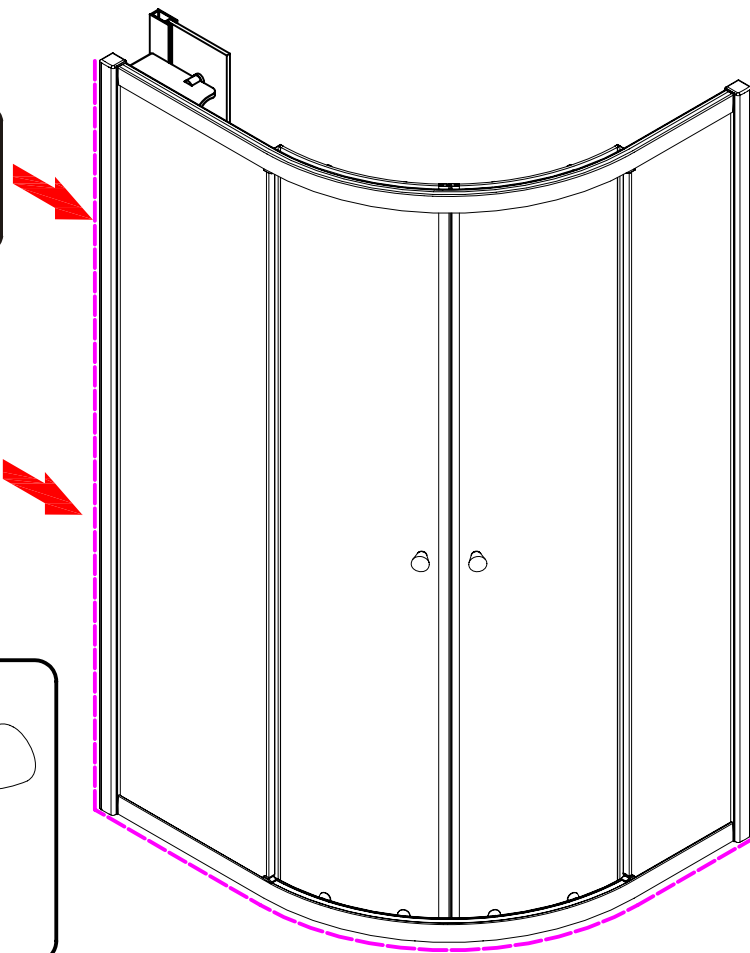
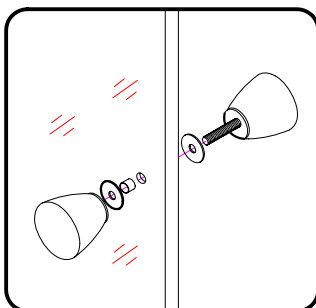
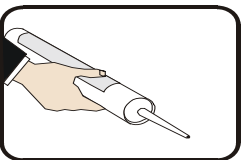
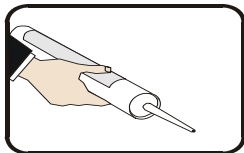
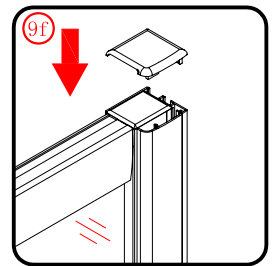
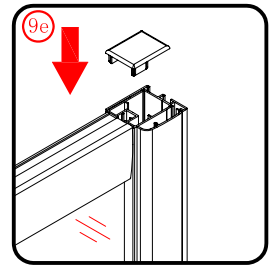
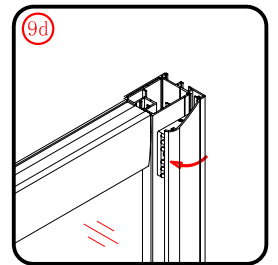
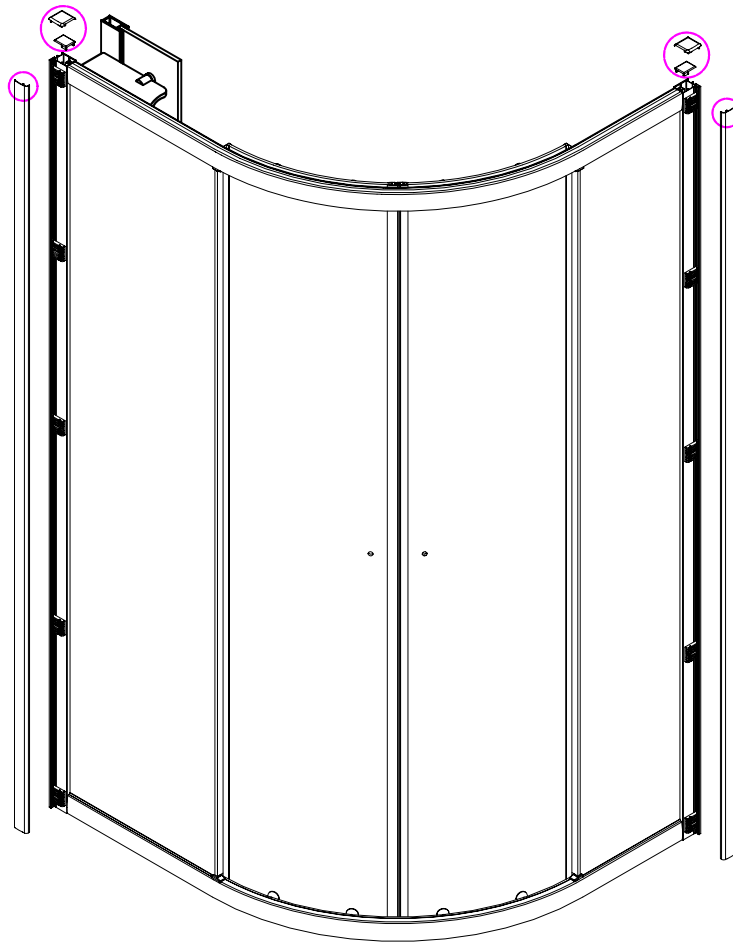
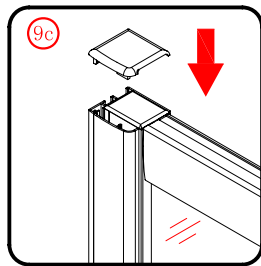
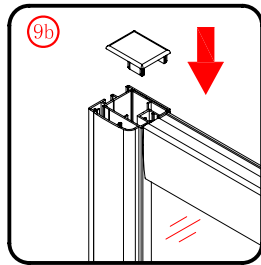
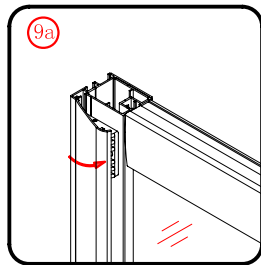

This product is heavy and will require two people to install.

